

#1

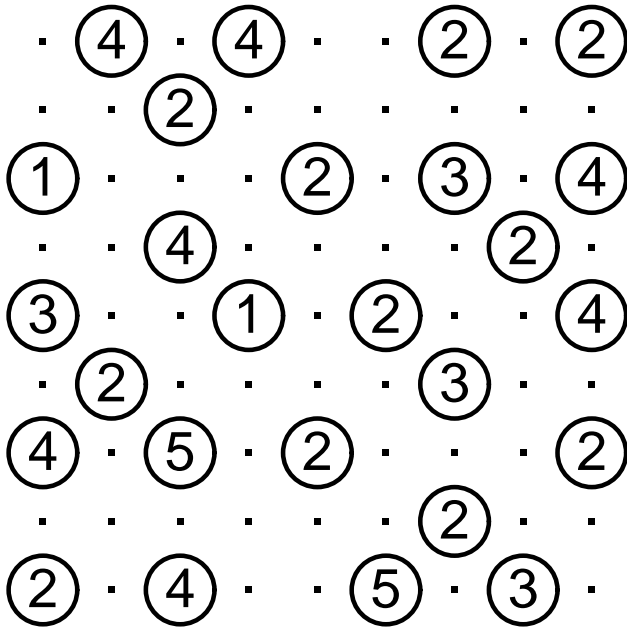

#2

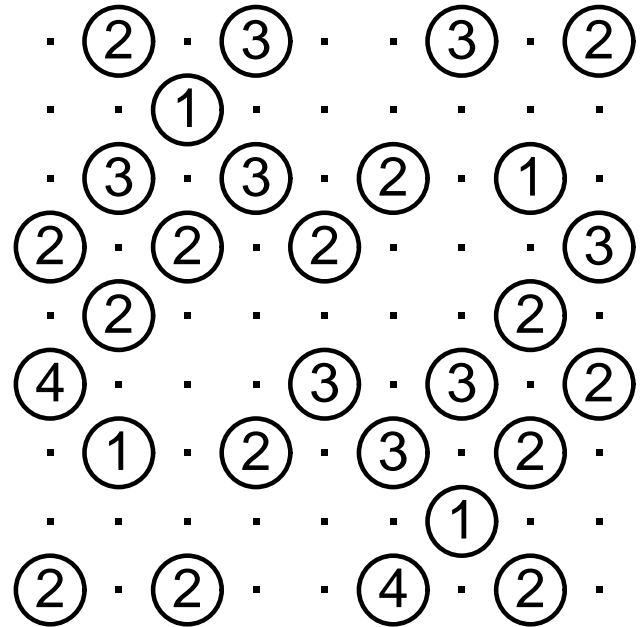

#3

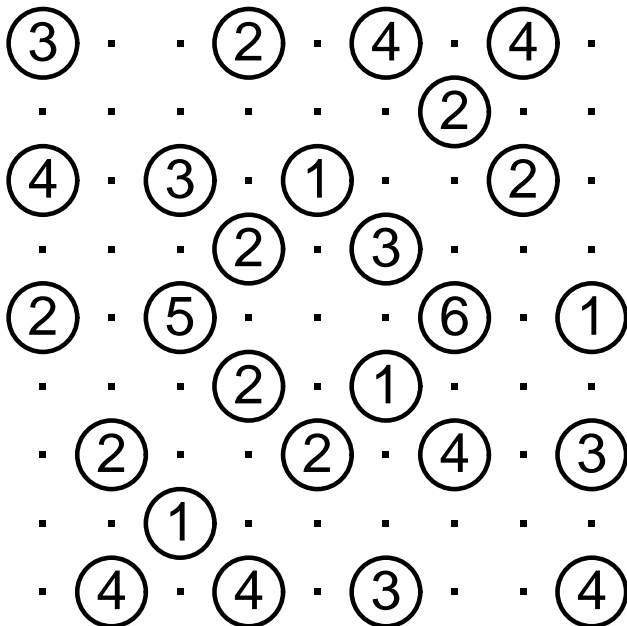

#4

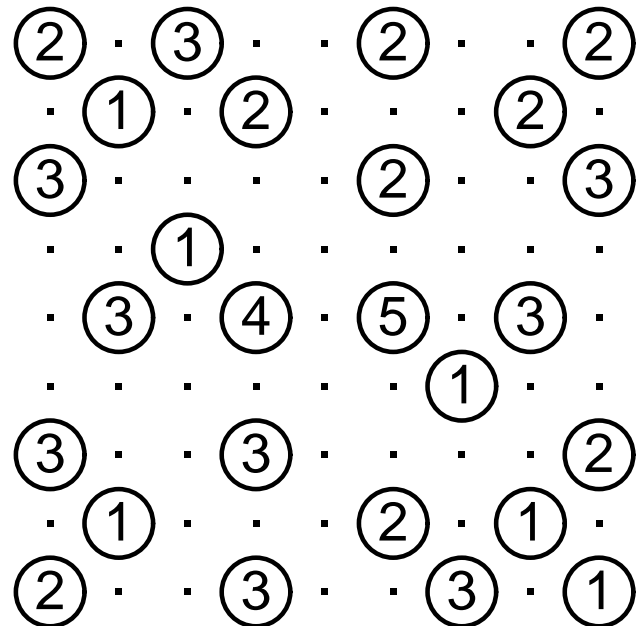

Connect these islands with bridges until each island can be reached from any other island, and each island has as many outgoing bridges as its number. You may only connect islands vertically or horizontally and bridges may not cross. There may be one or two bridges connecting pairs of islands, but no more than two. Each puzzle has a unique solution that can be found without making guesses.

#5

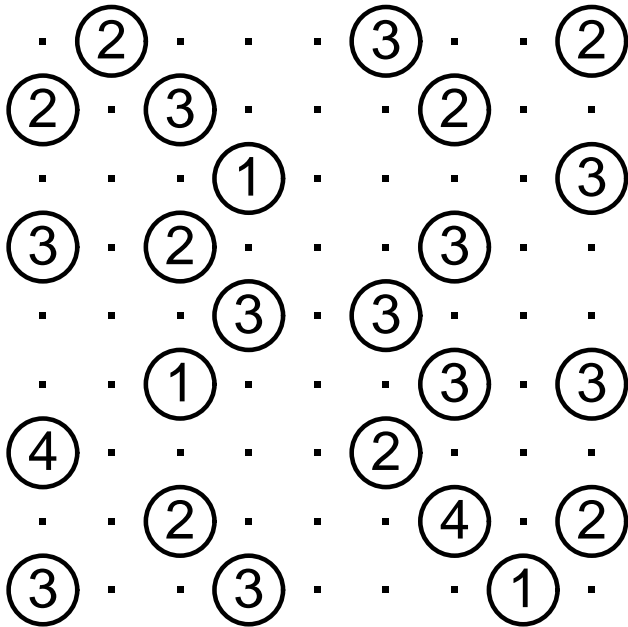

#6

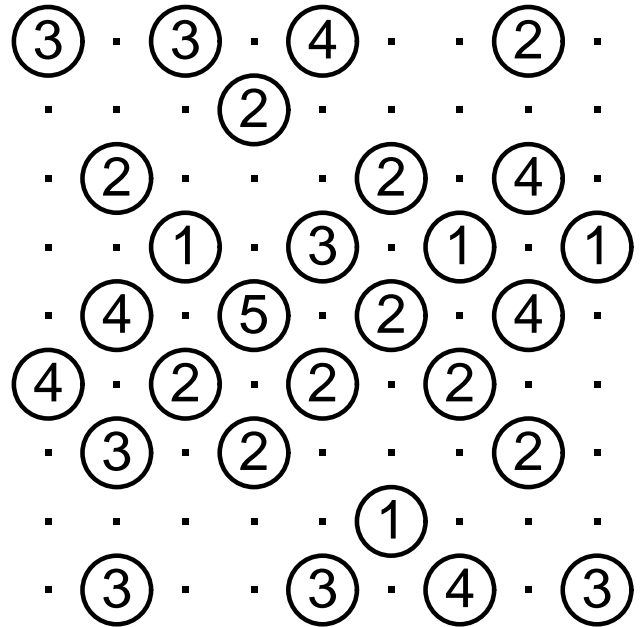

#7

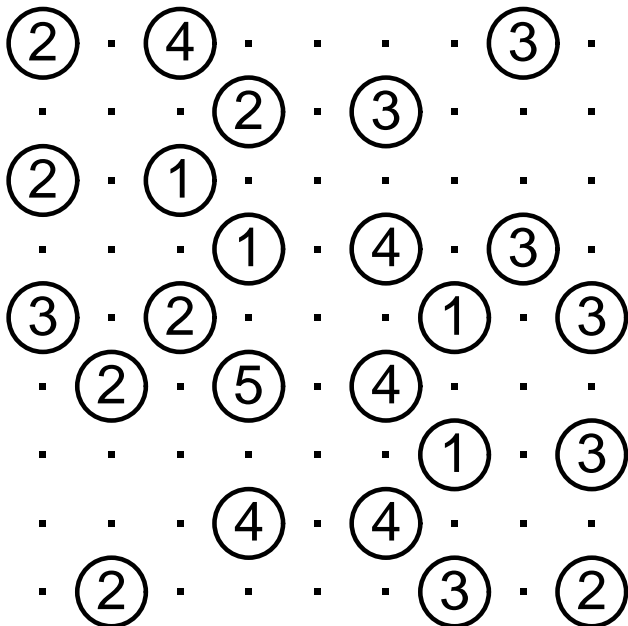

#8

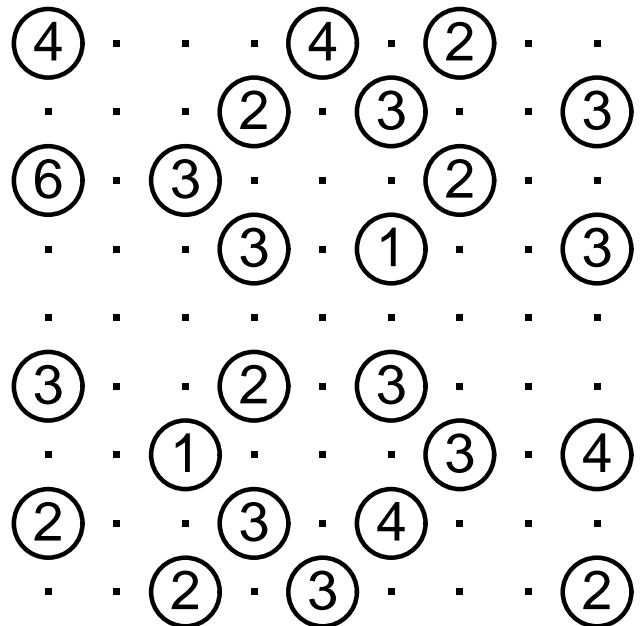

Connect these islands with bridges until each island can be reached from any other island, and each island has as many outgoing bridges as its number. You may only connect islands vertically or horizontally and bridges may not cross. There may be one or two bridges connecting pairs of islands, but no more than two. Each puzzle has a unique solution that can be found without making guesses.

#9

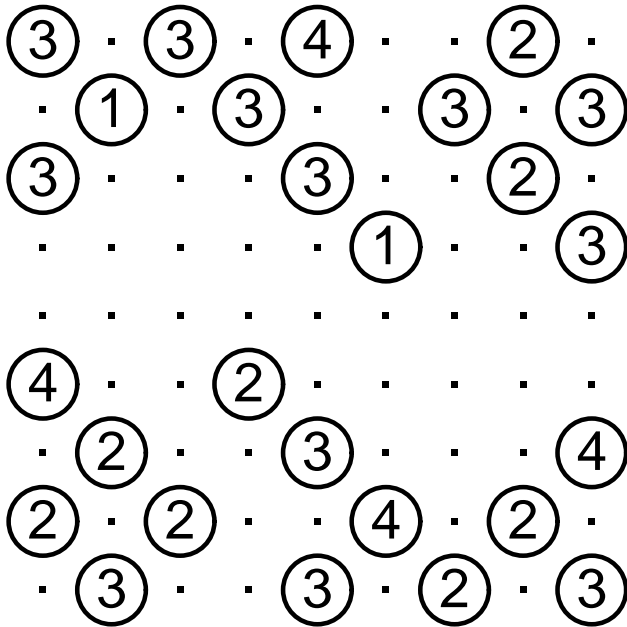

#10

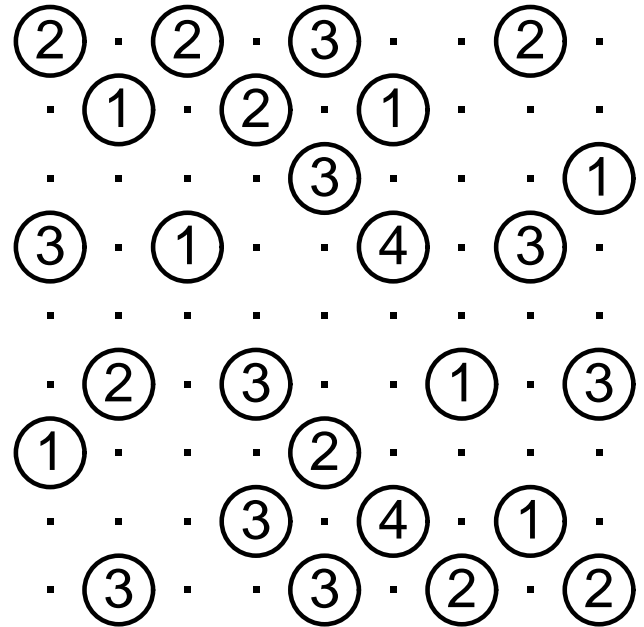

#11

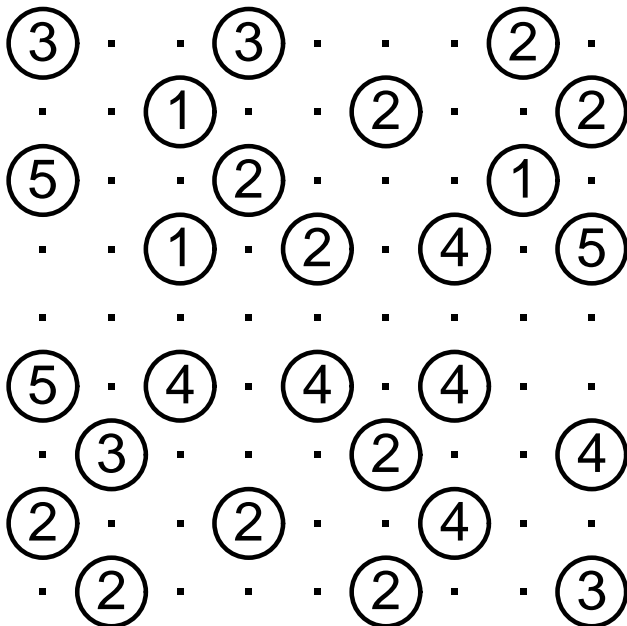

#12

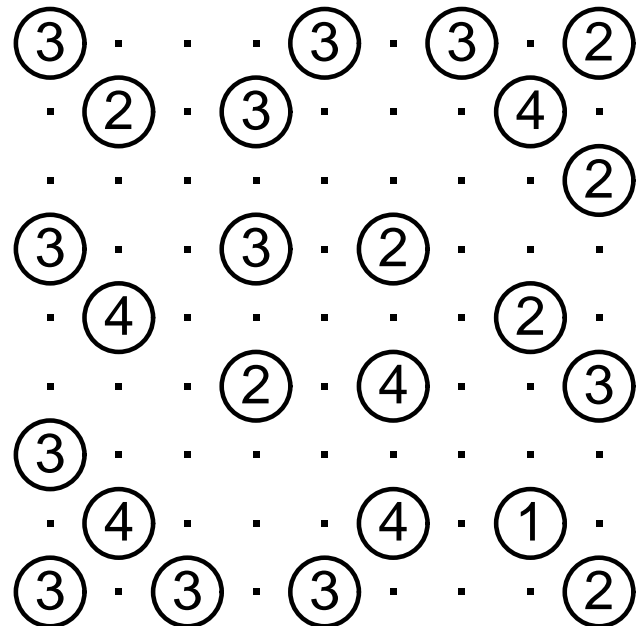

Connect these islands with bridges until each island can be reached from any other island, and each island has as many outgoing bridges as its number. You may only connect islands vertically or horizontally and bridges may not cross. There may be one or two bridges connecting pairs of islands, but no more than two. Each puzzle has a unique solution that can be found without making guesses.

#13

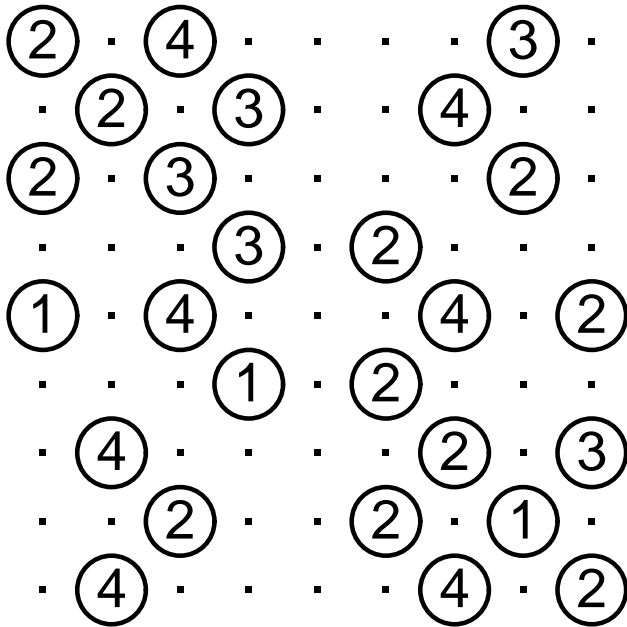

#14

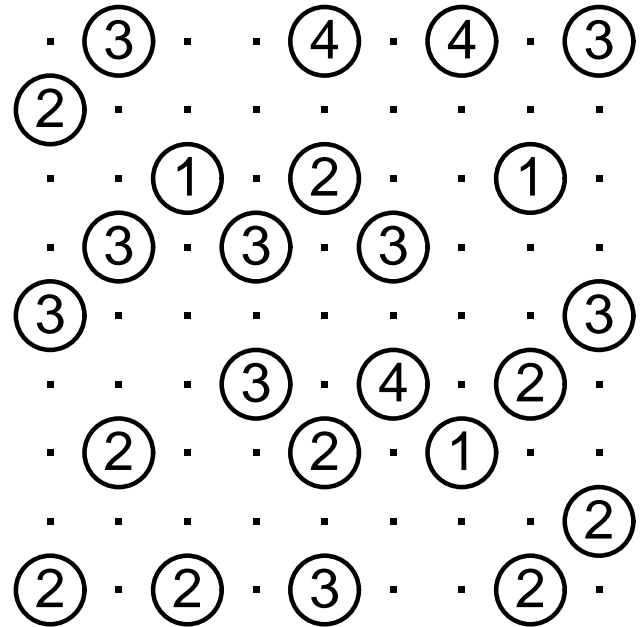

#15

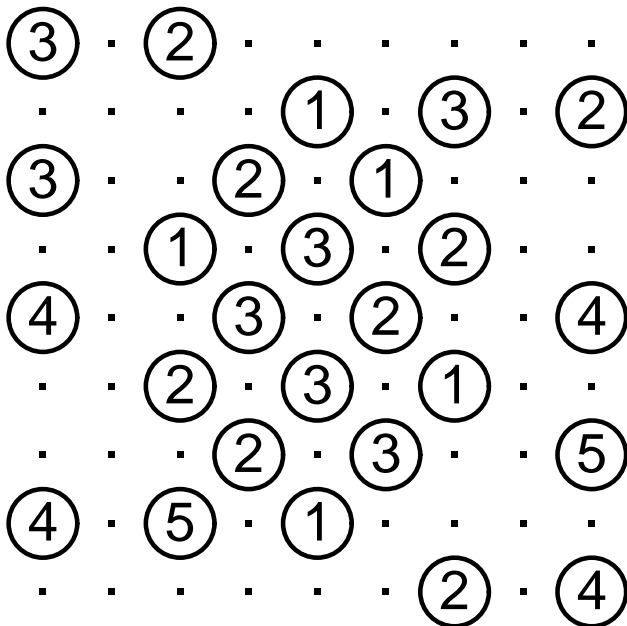

#16

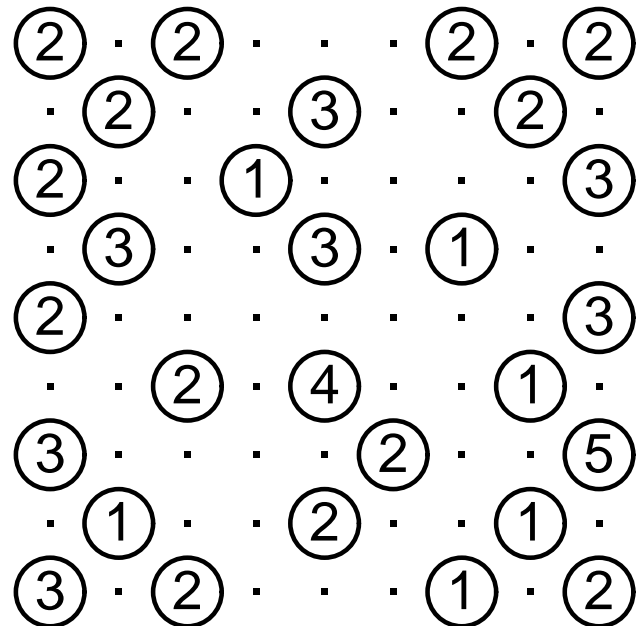

Connect these islands with bridges until each island can be reached from any other island, and each island has as many outgoing bridges as its number. You may only connect islands vertically or horizontally and bridges may not cross. There may be one or two bridges connecting pairs of islands, but no more than two. Each puzzle has a unique solution that can be found without making guesses.

#17

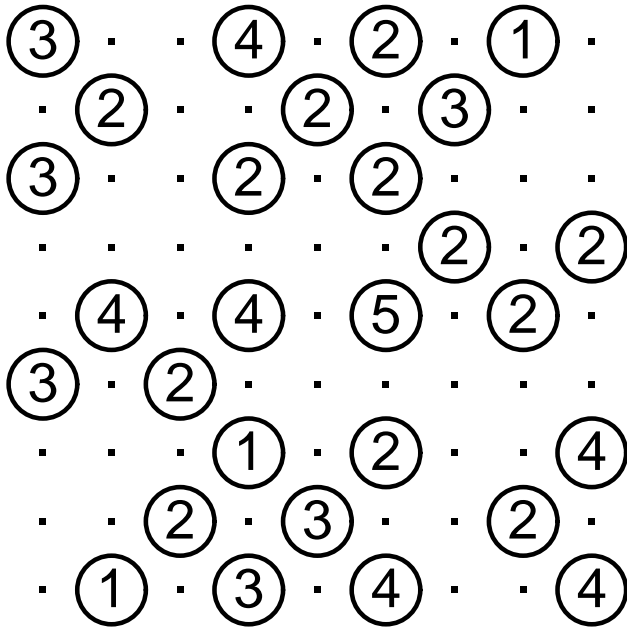

#18

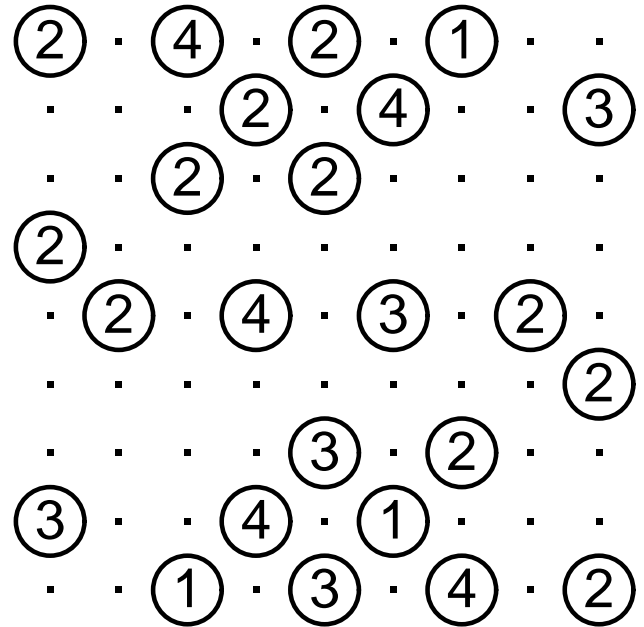

#19

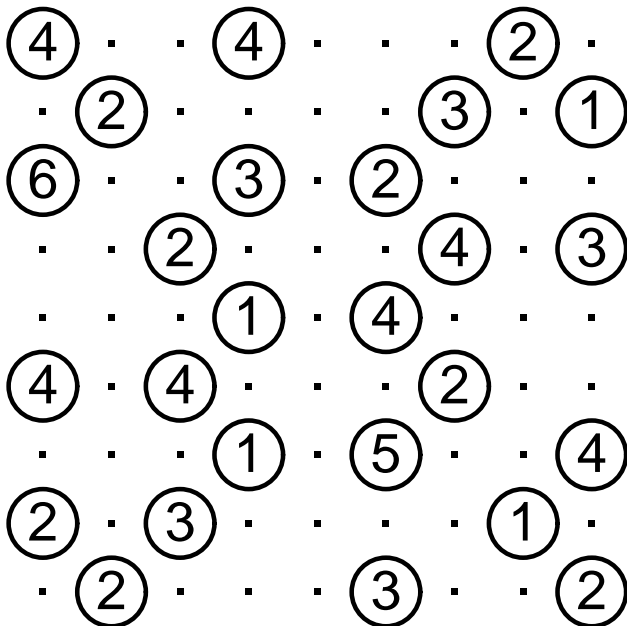

#20

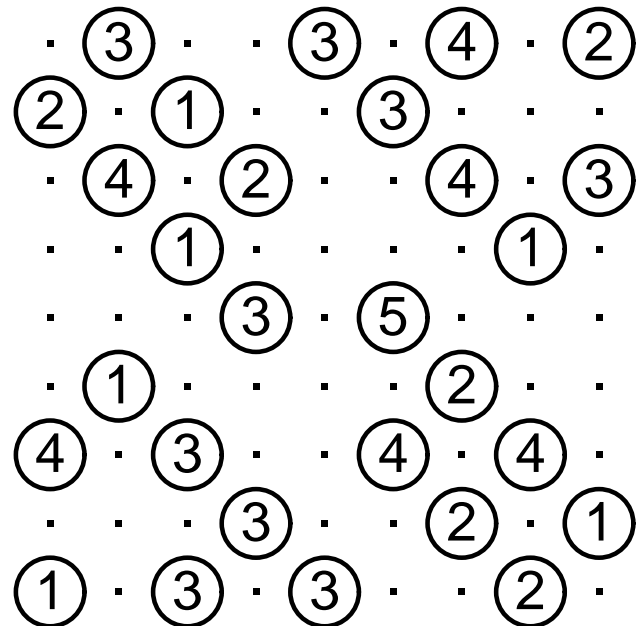

Connect these islands with bridges until each island can be reached from any other island, and each island has as many outgoing bridges as its number. You may only connect islands vertically or horizontally and bridges may not cross. There may be one or two bridges connecting pairs of islands, but no more than two. Each puzzle has a unique solution that can be found without making guesses.

#21

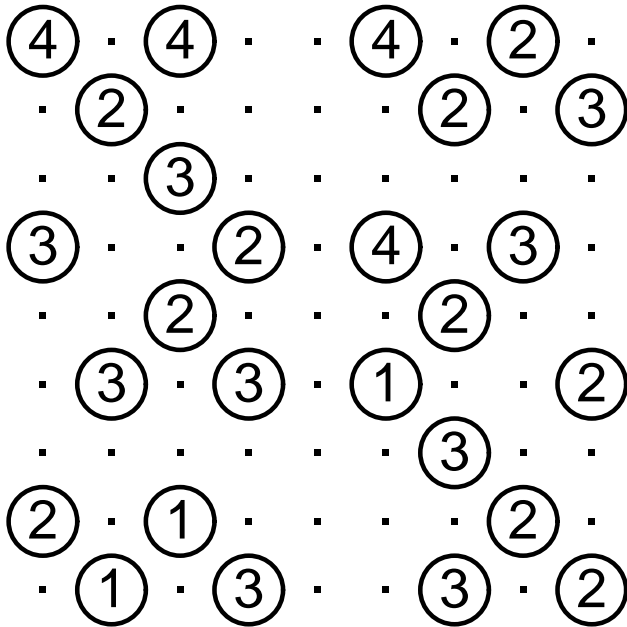

#22

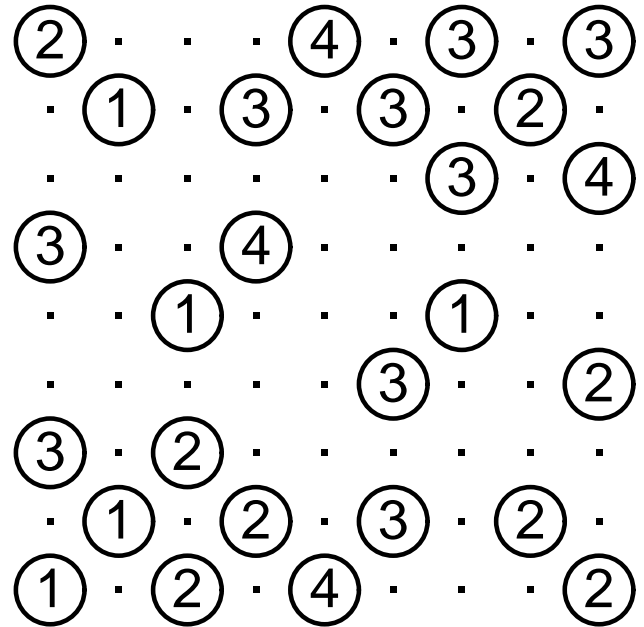

#23

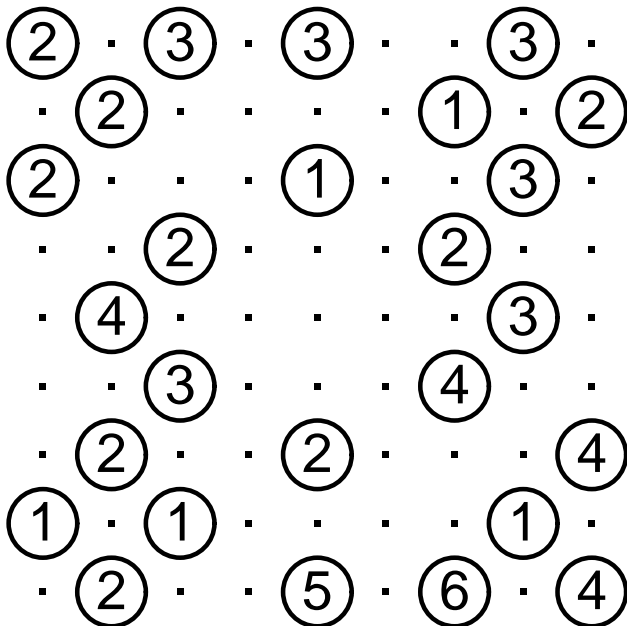

#24

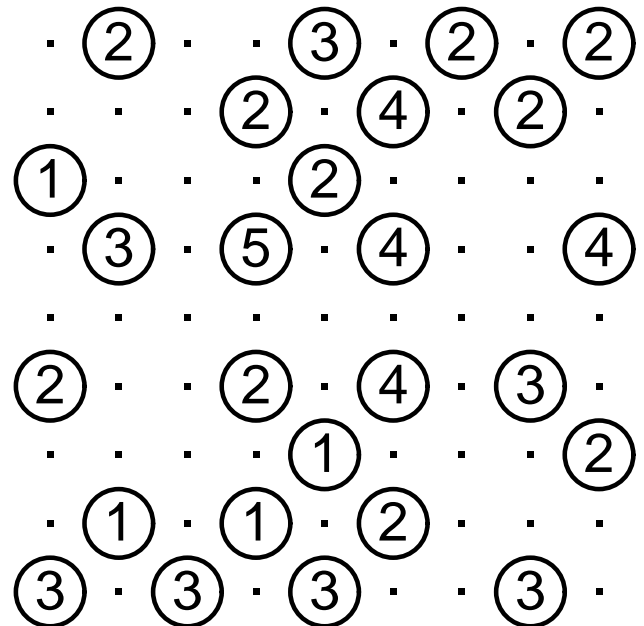

Connect these islands with bridges until each island can be reached from any other island, and each island has as many outgoing bridges as its number. You may only connect islands vertically or horizontally and bridges may not cross. There may be one or two bridges connecting pairs of islands, but no more than two. Each puzzle has a unique solution that can be found without making guesses.

#25

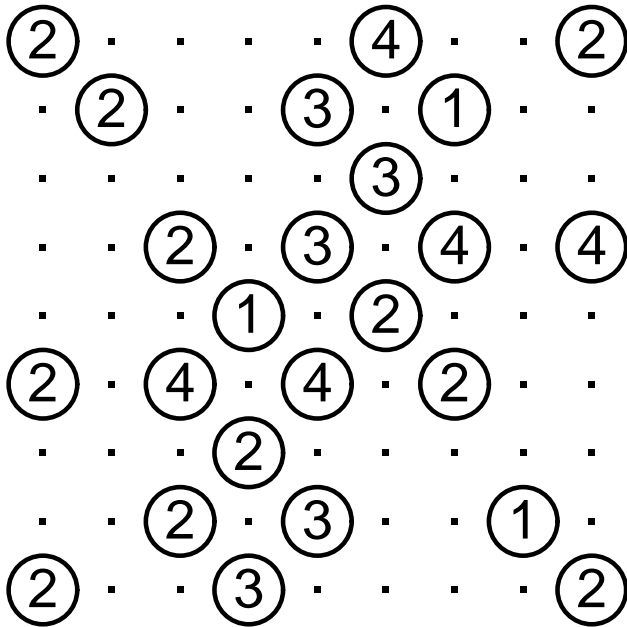

#26

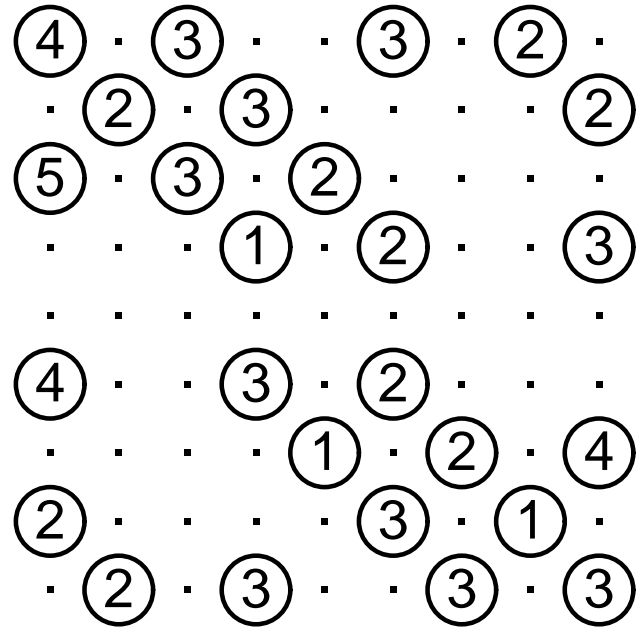

#27

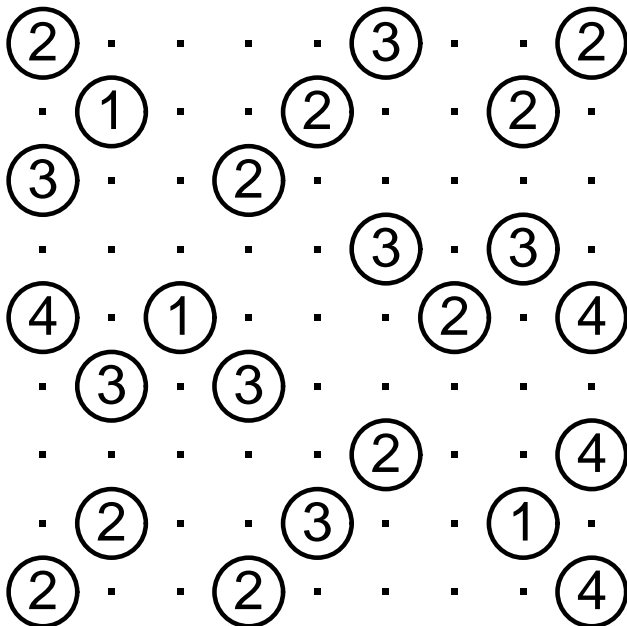

#28

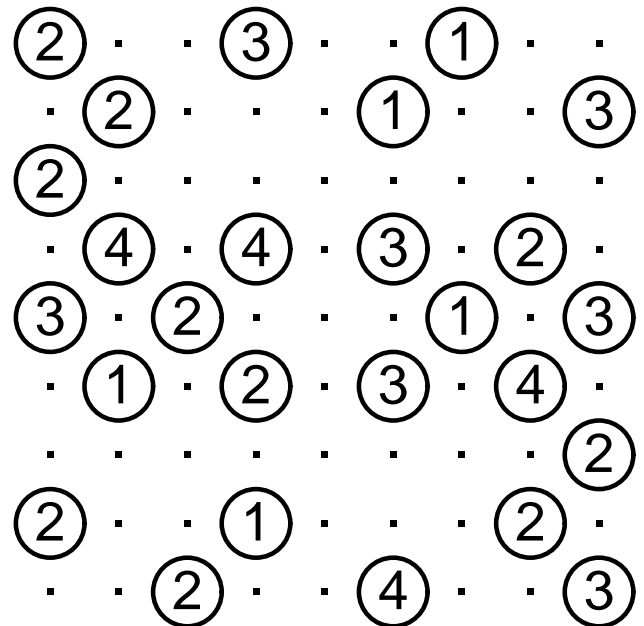

Connect these islands with bridges until each island can be reached from any other island, and each island has as many outgoing bridges as its number. You may only connect islands vertically or horizontally and bridges may not cross. There may be one or two bridges connecting pairs of islands, but no more than two. Each puzzle has a unique solution that can be found without making guesses.

#29

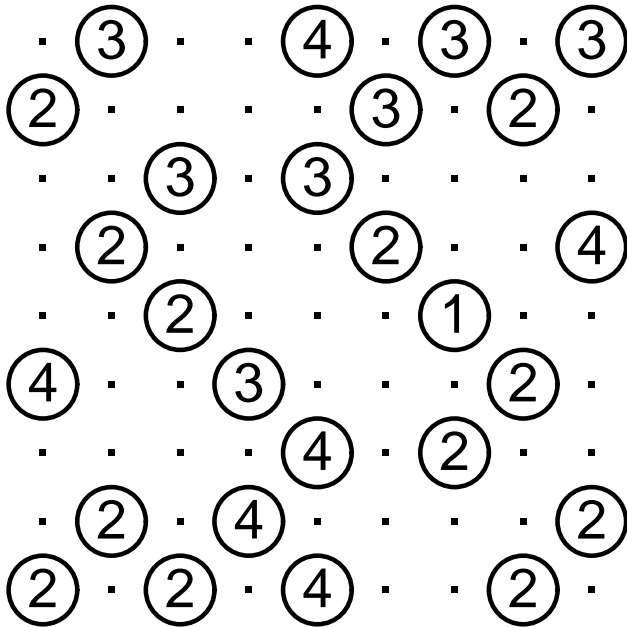

#30

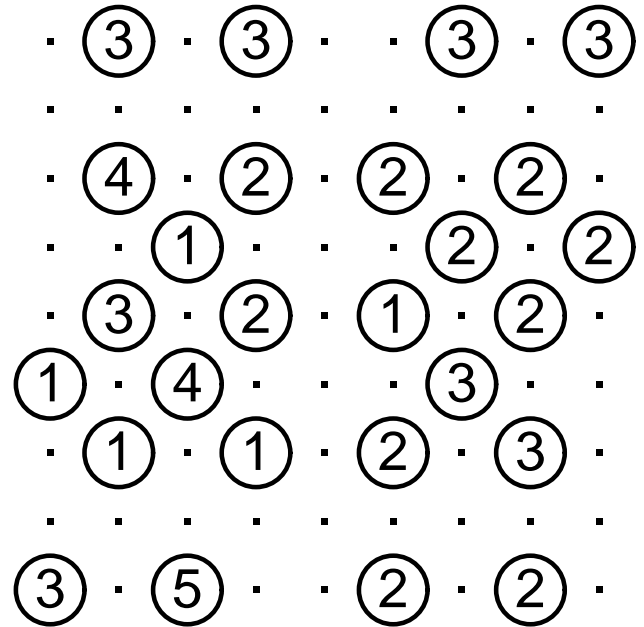

#31

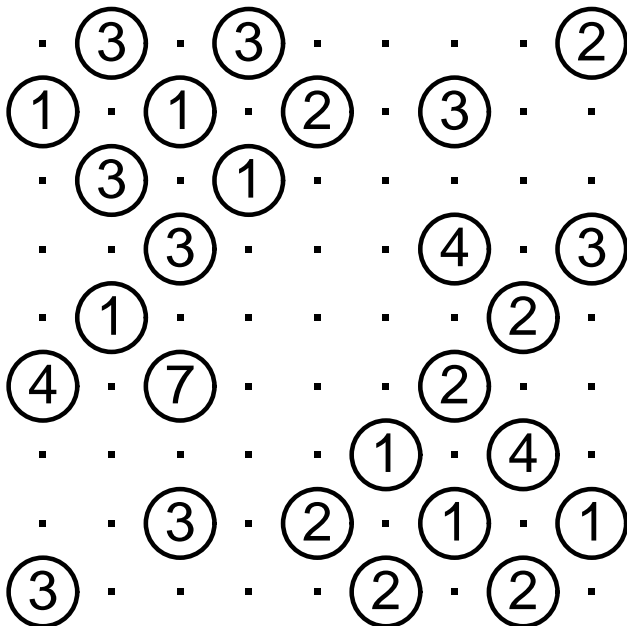

#32

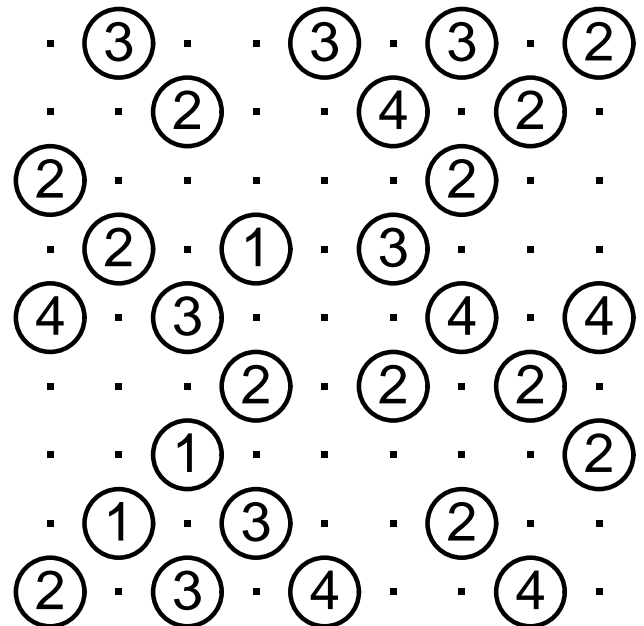

Connect these islands with bridges until each island can be reached from any other island, and each island has as many outgoing bridges as its number. You may only connect islands vertically or horizontally and bridges may not cross. There may be one or two bridges connecting pairs of islands, but no more than two. Each puzzle has a unique solution that can be found without making guesses.

9 x 9 Bridges by Krazydad

ANSWERS 1 - 16

#1

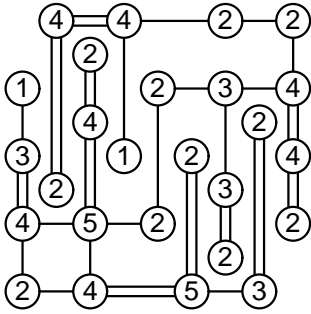

#2

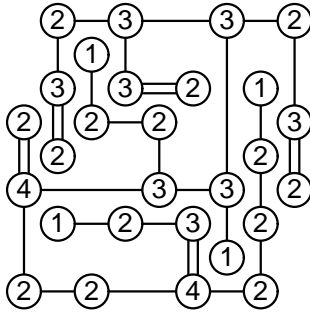

#3

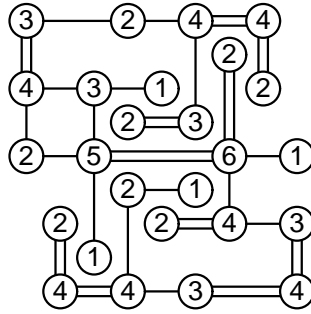

#4

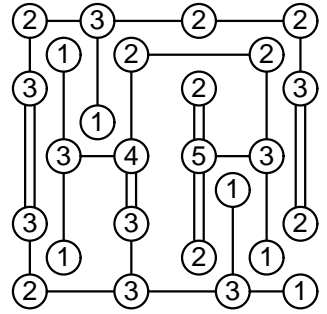

#5

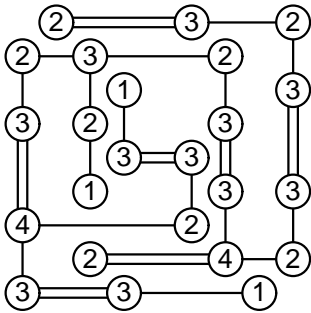

#6

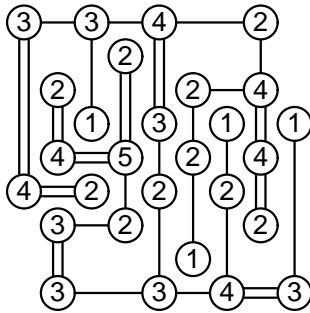

#7

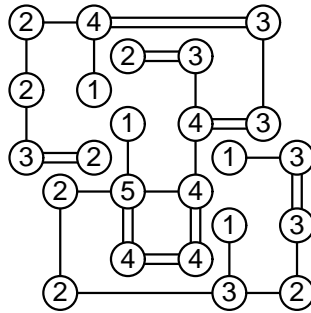

#8

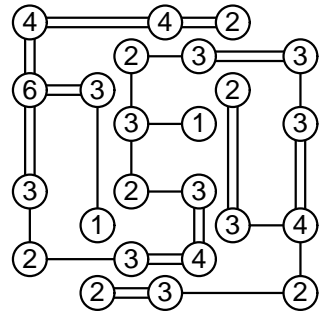

#9

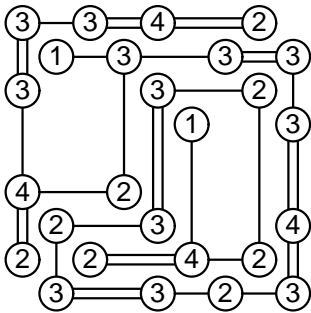

#10

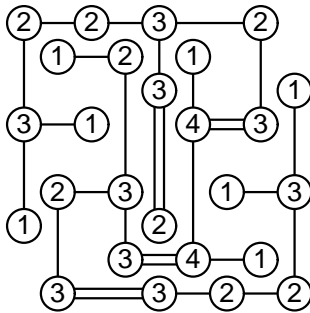

#11

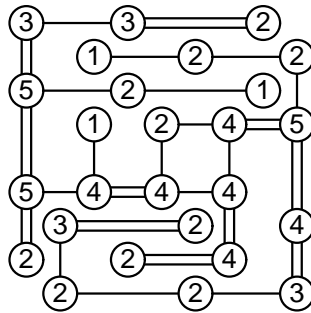

#12

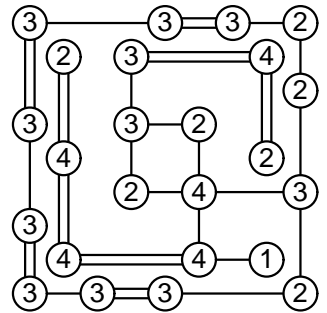

#13

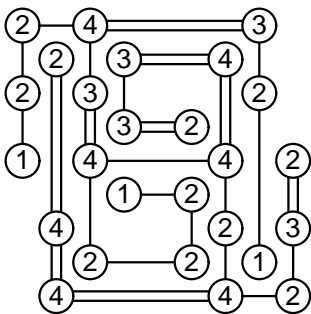

#14

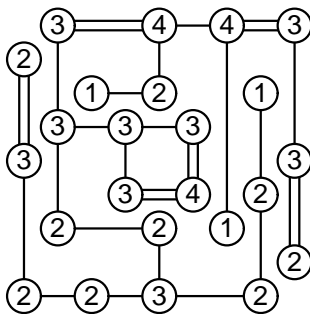

#15

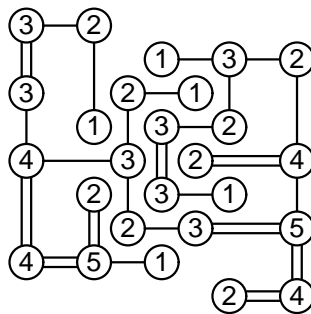

#16

