

Masyu #1-4

Medium Masyu Puzzles from Krazydad, Volume 1, Book 10

Masyu #1

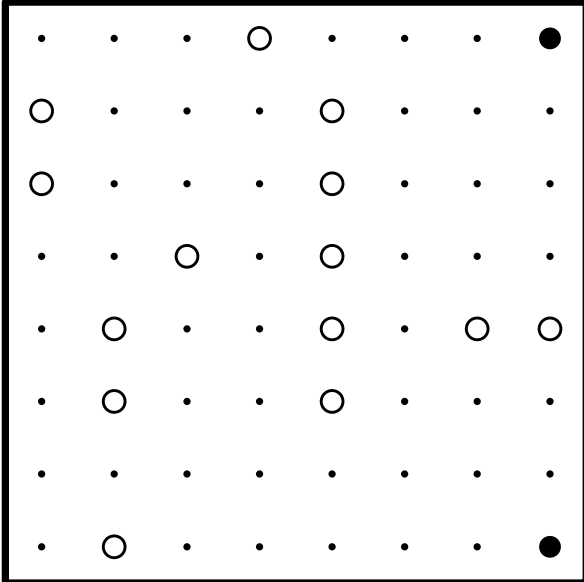

© 2015 Krazydad.com

Masyu #2

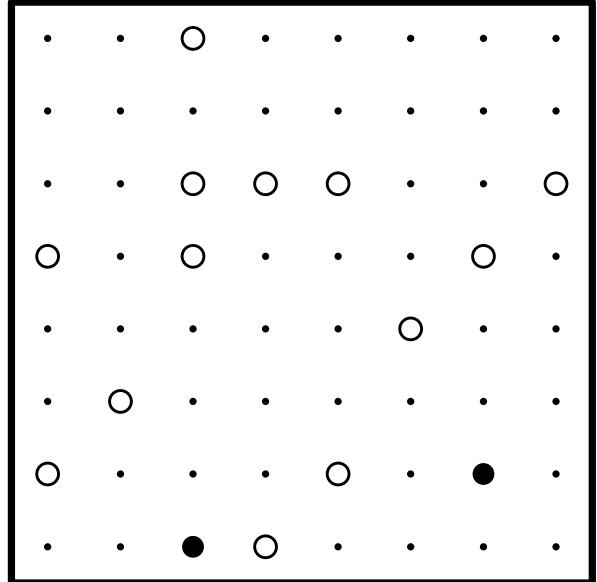

© 2015 Krazydad.com

Masyu #3

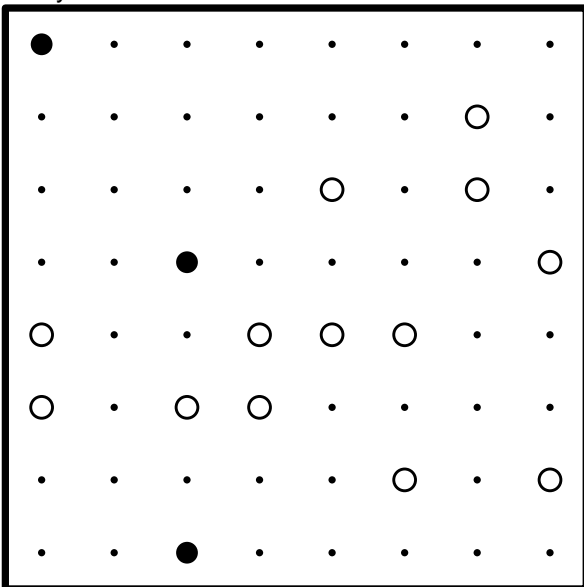

© 2015 Krazydad.com

Masyu #4

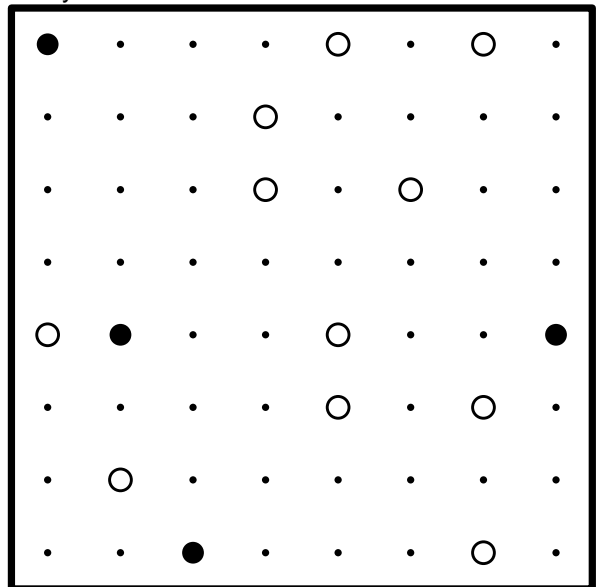

© 2015 Krazydad.com

The finished puzzle will contain a loop made of horizontal/vertical line segments that connects all the white and black circles. The line going thru a white circle must be straight. However, there must be at least one corner made on the dot immediate preceding or immediately following the white circle (or on both dots). The line going thru a black circle must turn a corner on the black circle. Both of the lines emanating from this corner need to go straight through the next dot before making any more turns.

Masyu #5-8

Medium Masyu Puzzles from Krazydad, Volume 1, Book 10

Masyu #5

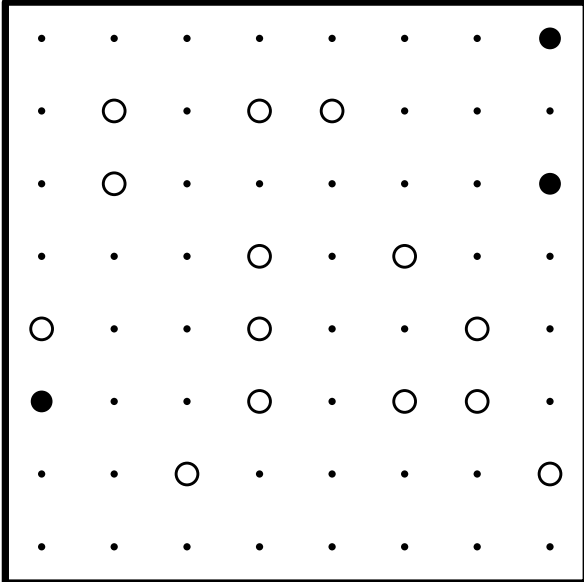

© 2015 Krazydad.com

Masyu #6

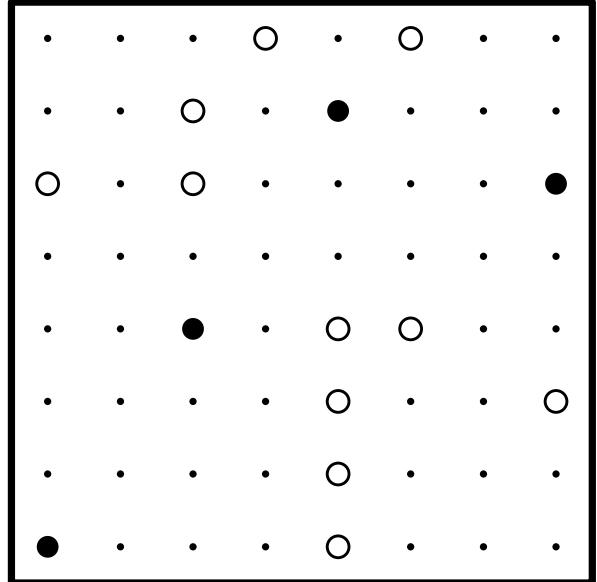

© 2015 Krazydad.com

Masyu #7

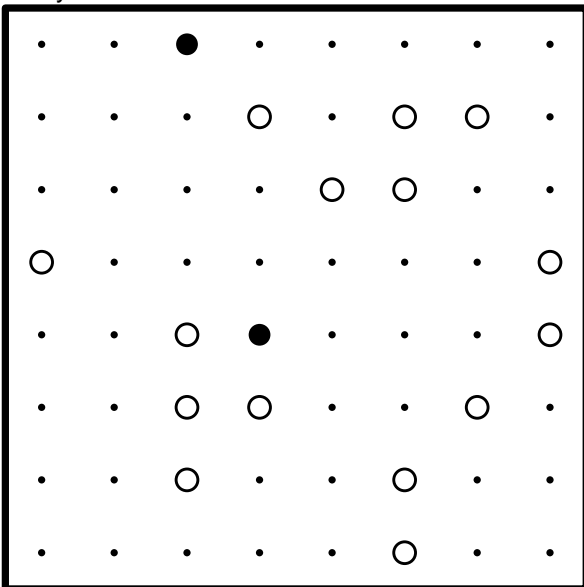

© 2015 Krazydad.com

Masyu #8

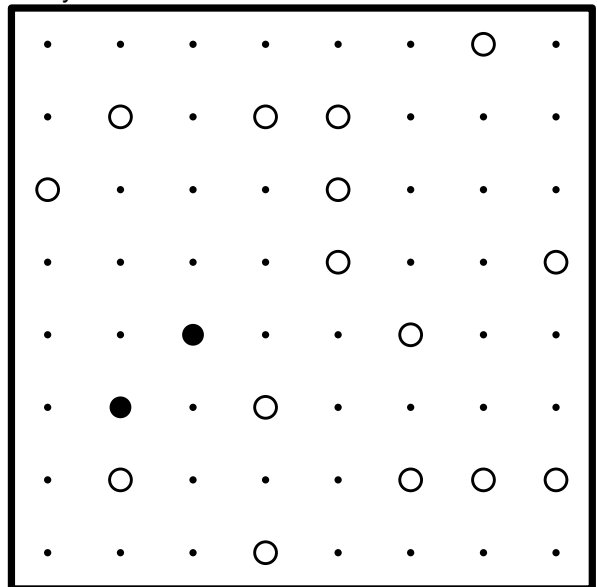

© 2015 Krazydad.com

The finished puzzle will contain a loop made of horizontal/vertical line segments that connects all the white and black circles. The line going thru a white circle must be straight. However, there must be at least one corner made on the dot immediate preceding or immediately following the white circle (or on both dots). The line going thru a black circle must turn a corner on the black circle. Both of the lines emanating from this corner need to go straight through the next dot before making any more turns.

Masyu #9-12

Medium Masyu Puzzles from Krazydad, Volume 1, Book 10

Masyu #9

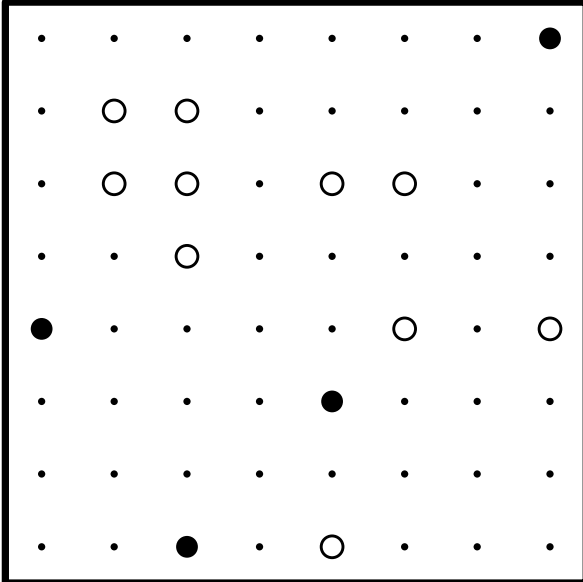

© 2015 Krazydad.com

Masyu #10

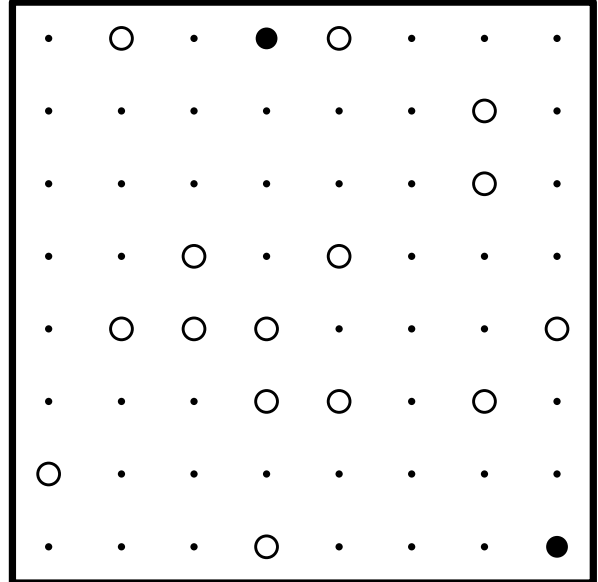

© 2015 Krazydad.com

Masyu #11

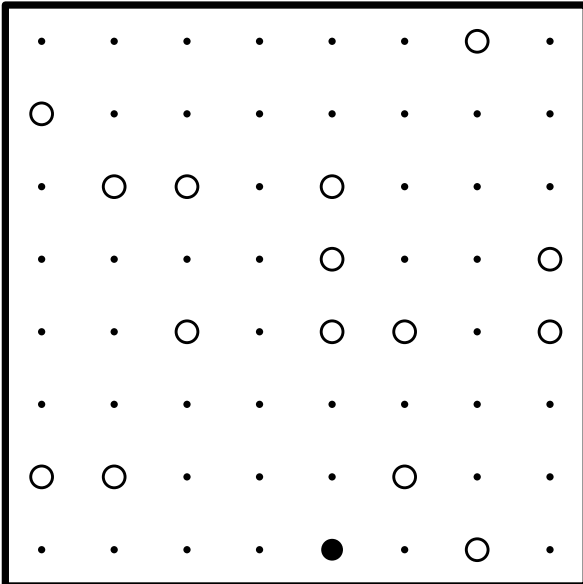

© 2015 Krazydad.com

Masyu #12

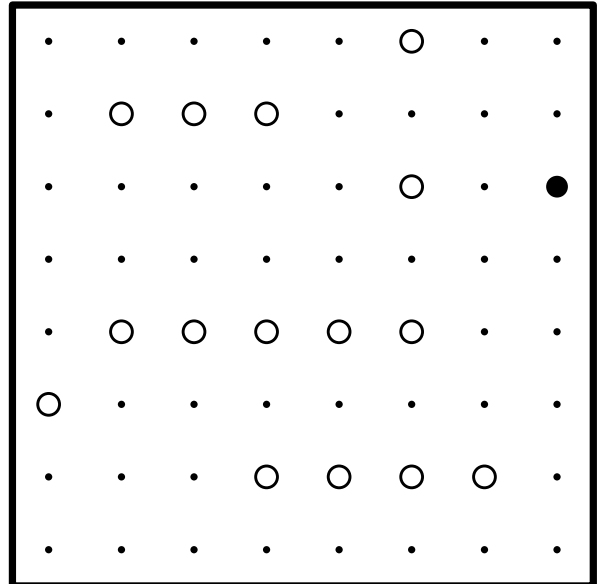

© 2015 Krazydad.com

The finished puzzle will contain a loop made of horizontal/vertical line segments that connects all the white and black circles. The line going thru a white circle must be straight. However, there must be at least one corner made on the dot immediate preceding or immediately following the white circle (or on both dots). The line going thru a black circle must turn a corner on the black circle. Both of the lines emanating from this corner need to go straight through the next dot before making any more turns.

Masyu #13-16

Medium Masyu Puzzles from Krazydad, Volume 1, Book 10

Masyu #13

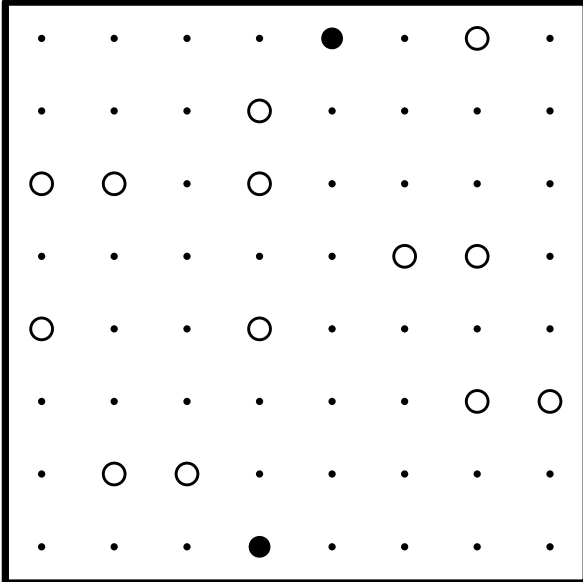

© 2015 Krazydad.com

Masyu #14

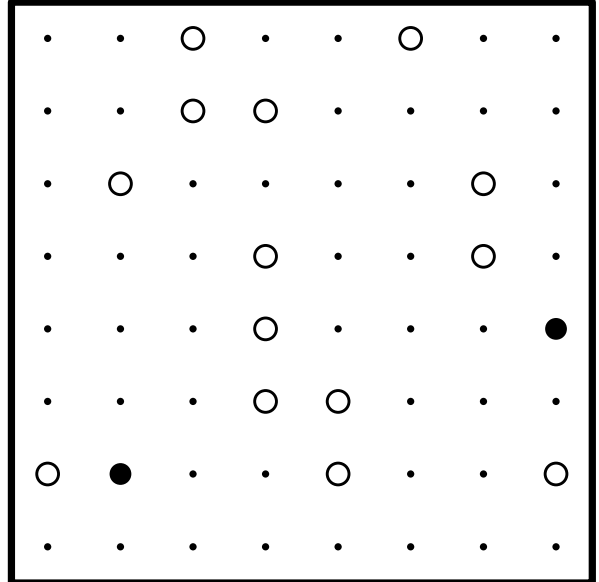

© 2015 Krazydad.com

Masyu #15

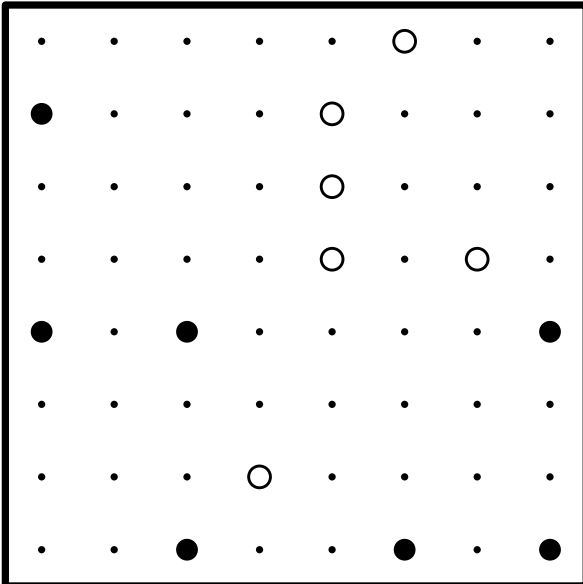

© 2015 Krazydad.com

Masyu #16

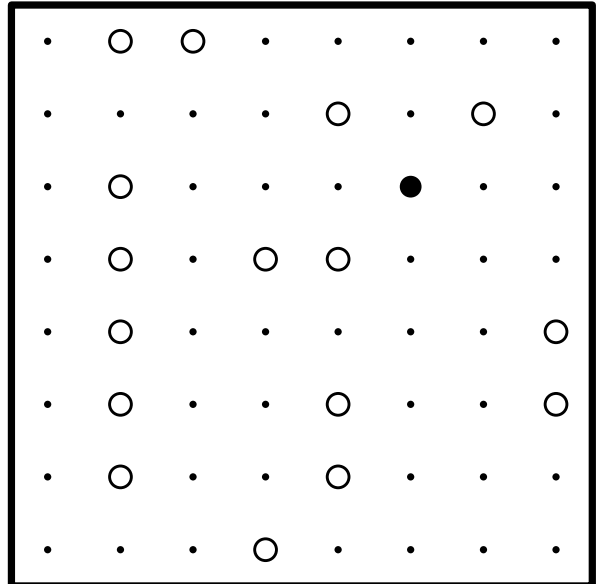

© 2015 Krazydad.com

The finished puzzle will contain a loop made of horizontal/vertical line segments that connects all the white and black circles. The line going thru a white circle must be straight. However, there must be at least one corner made on the dot immediate preceding or immediately following the white circle (or on both dots). The line going thru a black circle must turn a corner on the black circle. Both of the lines emanating from this corner need to go straight through the next dot before making any more turns.

Masyu #17-20

Medium Masyu Puzzles from Krazydad, Volume 1, Book 10

Masyu #17

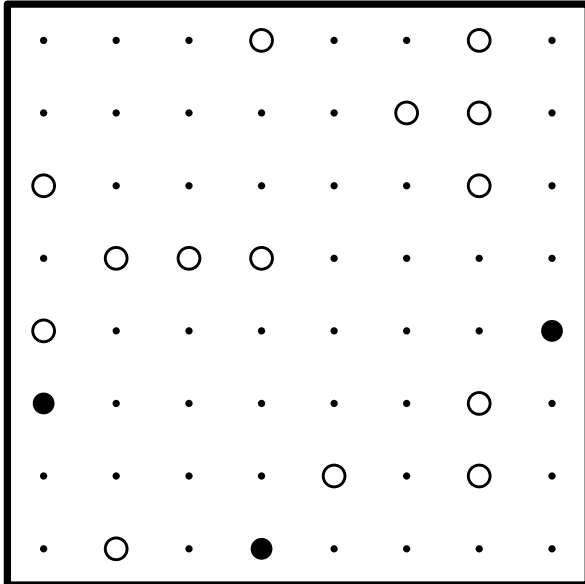

© 2015 Krazydad.com

Masyu #18

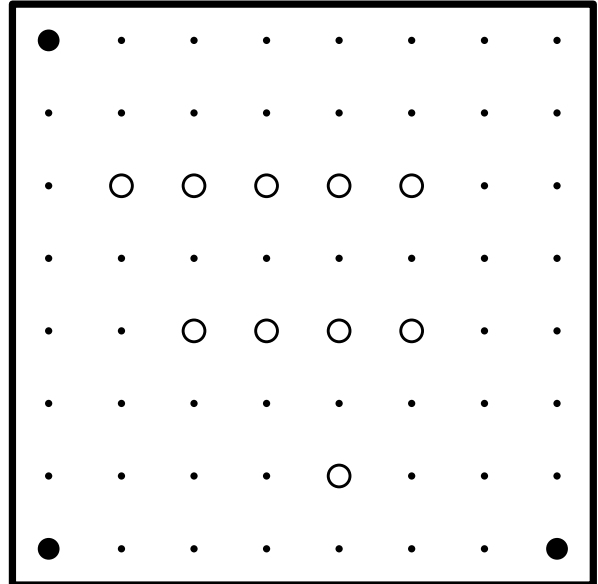

© 2015 Krazydad.com

Masyu #19

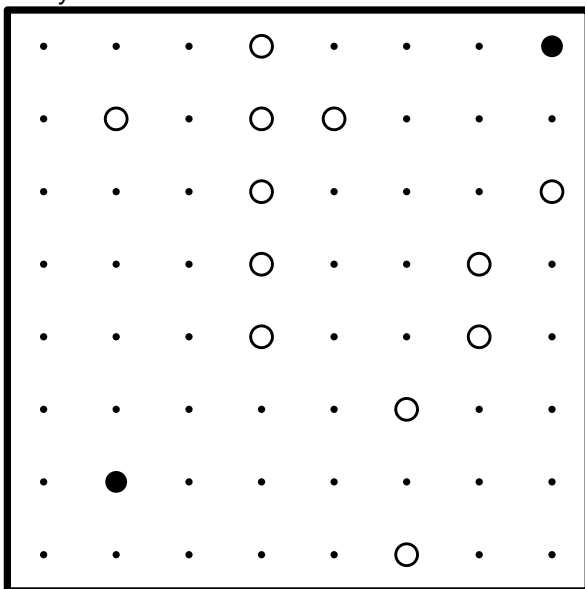

© 2015 Krazydad.com

Masyu #20

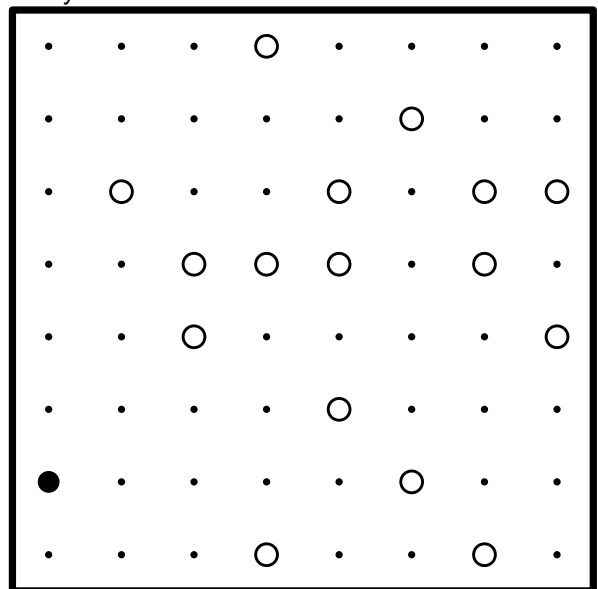

© 2015 Krazydad.com

The finished puzzle will contain a loop made of horizontal/vertical line segments that connects all the white and black circles. The line going thru a white circle must be straight. However, there must be at least one corner made on the dot immediate preceding or immediately following the white circle (or on both dots). The line going thru a black circle must turn a corner on the black circle. Both of the lines emanating from this corner need to go straight through the next dot before making any more turns.

Masyu #21-24

Medium Masyu Puzzles from Krazydad, Volume 1, Book 10

Masyu #21

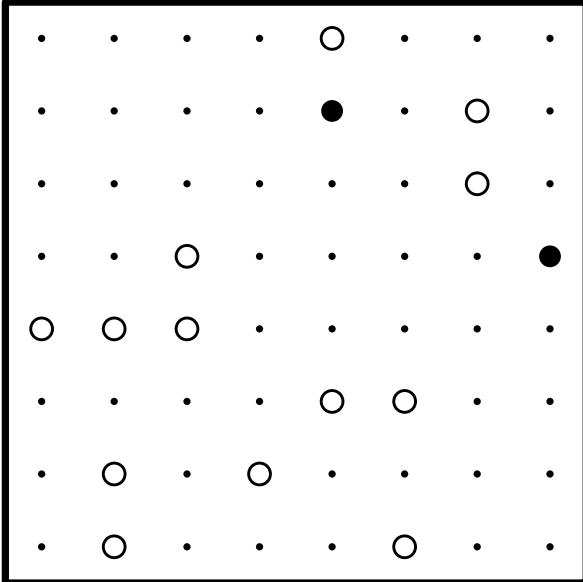

© 2015 Krazydad.com

Masyu #22

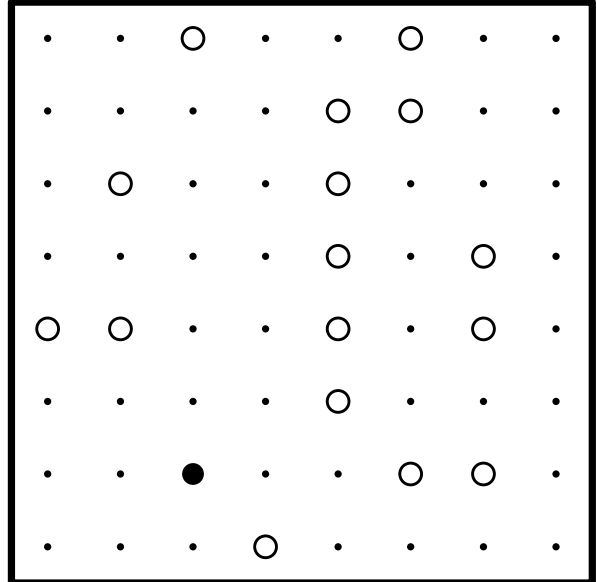

© 2015 Krazydad.com

Masyu #23

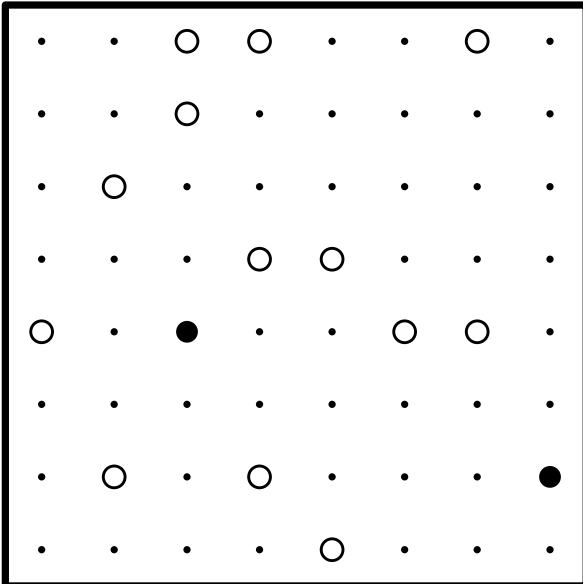

© 2015 Krazydad.com

Masyu #24

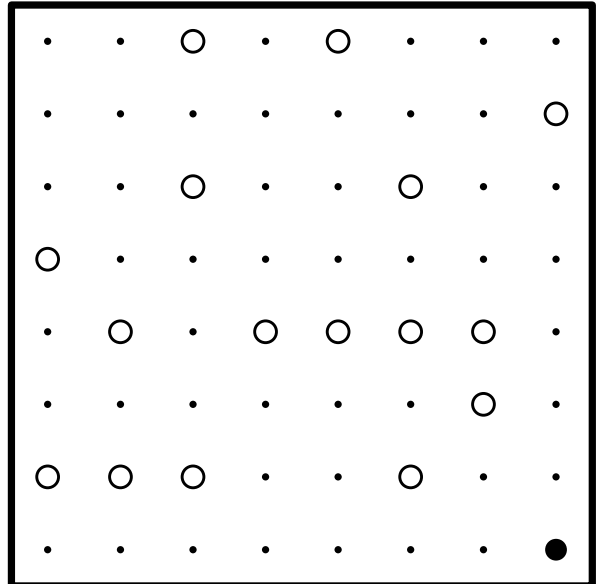

© 2015 Krazydad.com

The finished puzzle will contain a loop made of horizontal/vertical line segments that connects all the white and black circles. The line going thru a white circle must be straight. However, there must be at least one corner made on the dot immediate preceding or immediately following the white circle (or on both dots). The line going thru a black circle must turn a corner on the black circle. Both of the lines emanating from this corner need to go straight through the next dot before making any more turns.

Masyu #25-28

Medium Masyu Puzzles from Krazydad, Volume 1, Book 10

Masyu #25

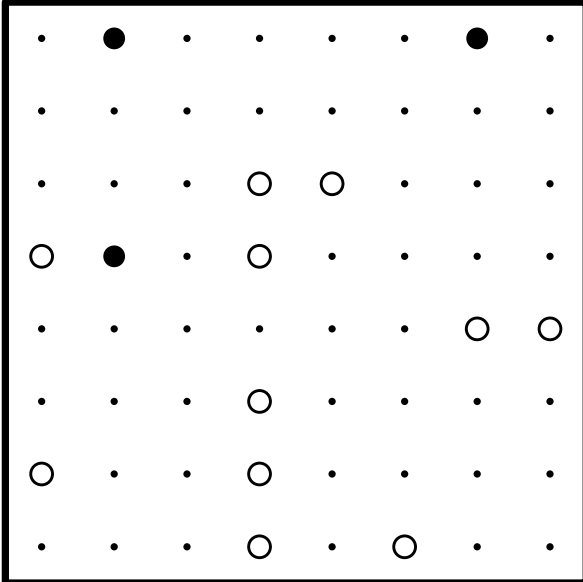

© 2015 Krazydad.com

Masyu #26

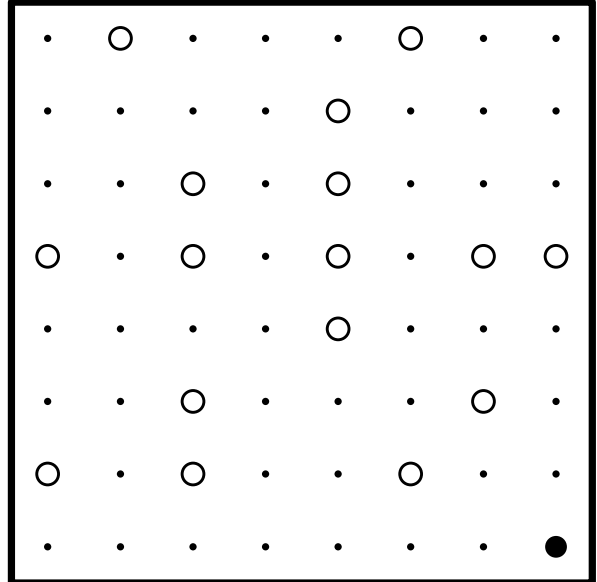

© 2015 Krazydad.com

Masyu #27

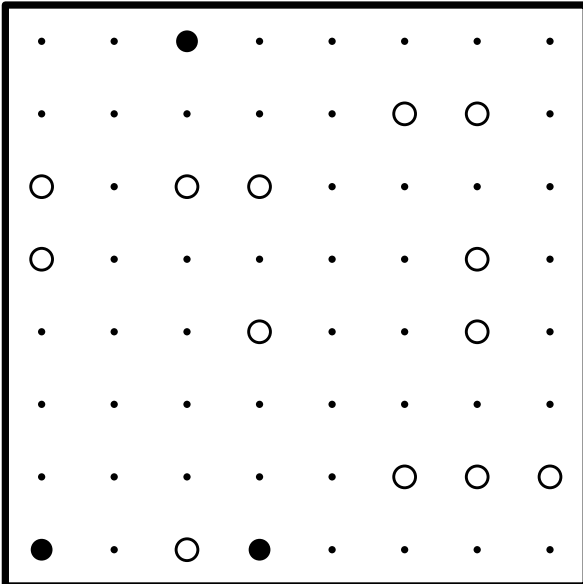

© 2015 Krazydad.com

Masyu #28

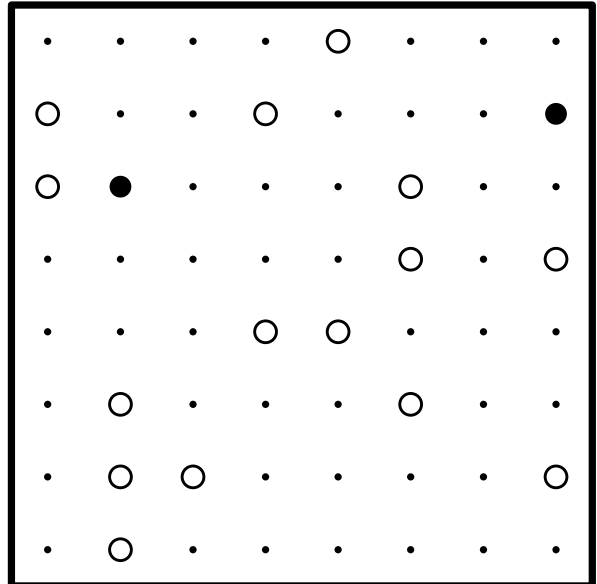

© 2015 Krazydad.com

The finished puzzle will contain a loop made of horizontal/vertical line segments that connects all the white and black circles. The line going thru a white circle must be straight. However, there must be at least one corner made on the dot immediate preceding or immediately following the white circle (or on both dots). The line going thru a black circle must turn a corner on the black circle. Both of the lines emanating from this corner need to go straight through the next dot before making any more turns.

Masyu #29-32

Medium Masyu Puzzles from Krazydad, Volume 1, Book 10

Masyu #29

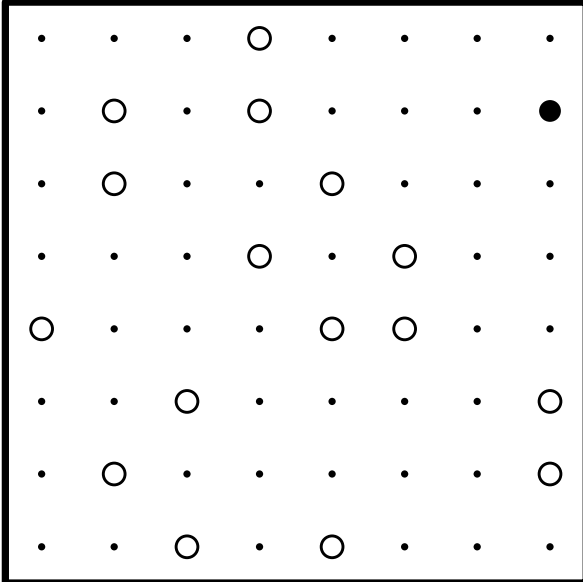

© 2015 Krazydad.com

Masyu #30

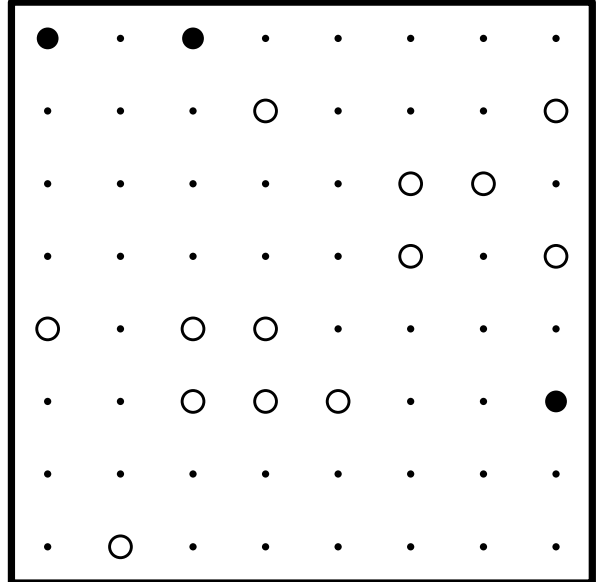

© 2015 Krazydad.com

Masyu #31

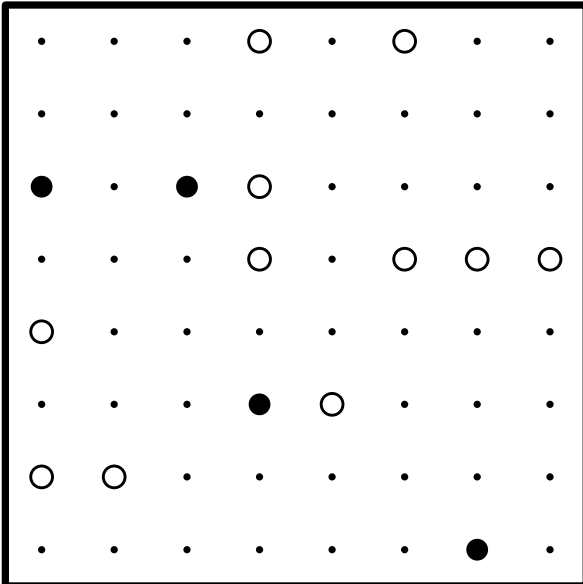

© 2015 Krazydad.com

Masyu #32

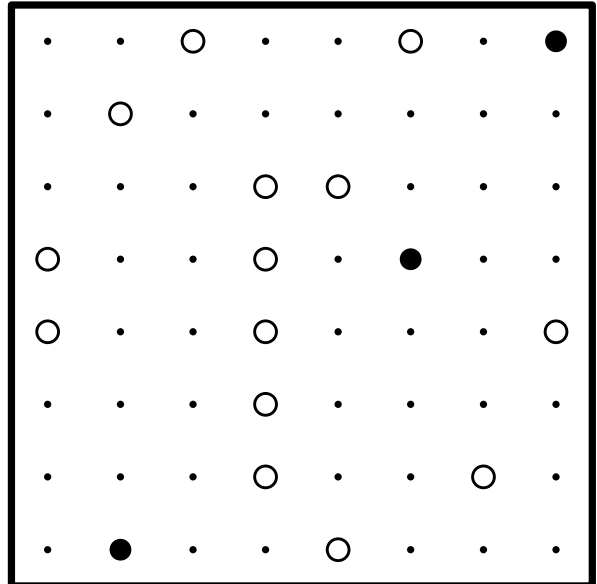

© 2015 Krazydad.com

The finished puzzle will contain a loop made of horizontal/vertical line segments that connects all the white and black circles. The line going thru a white circle must be straight. However, there must be at least one corner made on the dot immediate preceding or immediately following the white circle (or on both dots). The line going thru a black circle must turn a corner on the black circle. Both of the lines emanating from this corner need to go straight through the next dot before making any more turns.

Answers #1-12

Medium Masyu Puzzles from Krazydad, Volume 1, Book 10

#1

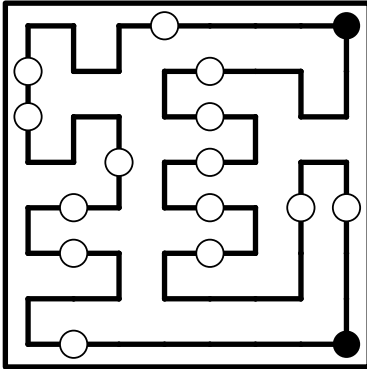

© 2015 Krazydad.com

#2

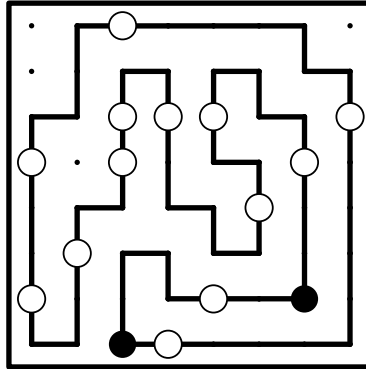

© 2015 Krazydad.com

#3

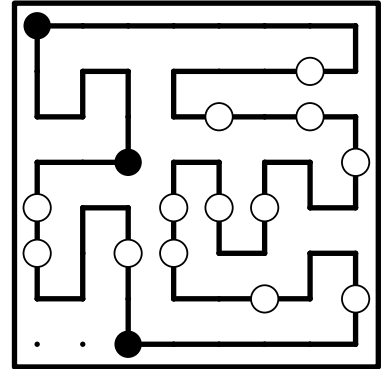

© 2015 Krazydad.com

#4

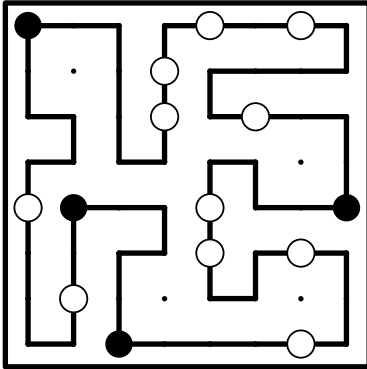

© 2015 Krazydad.com

#5

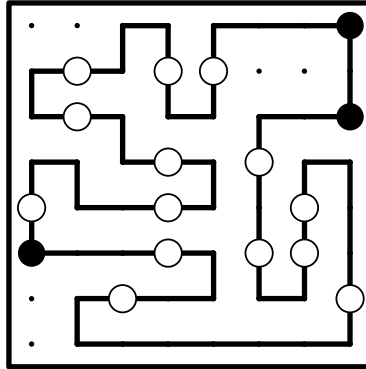

© 2015 Krazydad.com

#6

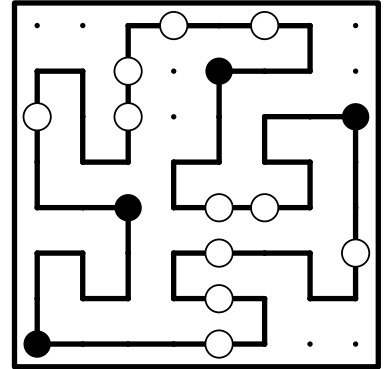

© 2015 Krazydad.com

#7

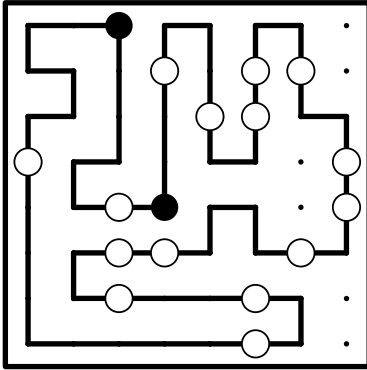

© 2015 Krazydad.com

#8

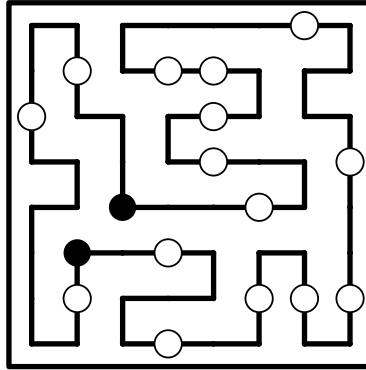

© 2015 Krazydad.com

#9

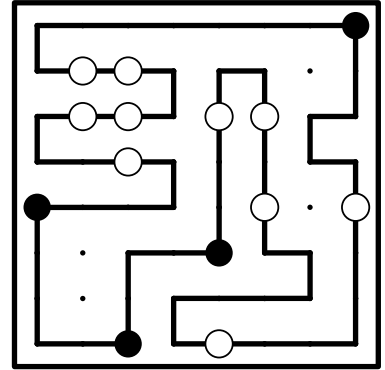

© 2015 Krazydad.com

#10

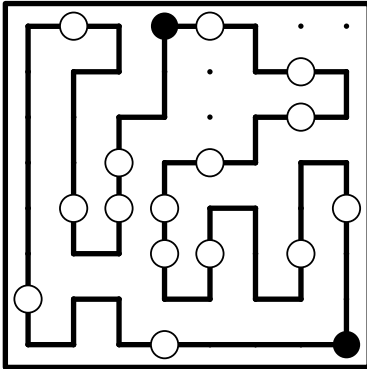

© 2015 Krazydad.com

#11

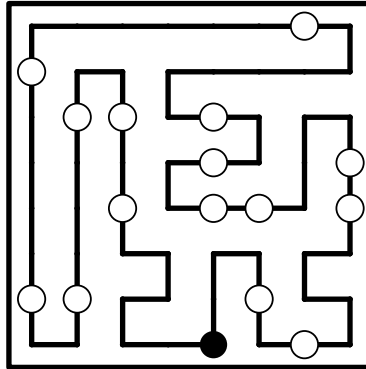

© 2015 Krazydad.com

#12

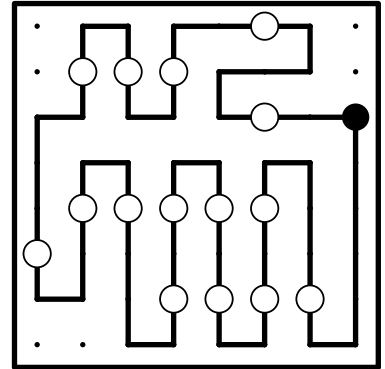

© 2015 Krazydad.com

